



19011099A01

1. Overview

Thank you for purchasing the GL10-4AD analog input module developed and manufactured independently by Inovance.

GL10-4AD is a 4-channel analog input module used together with the AM600 series medium-sized PLC and the H3U series PLC main modules. It supports voltage and current input, with a resolution of up to 16 bits.

This guide describes the specifications, characteristics and using methods of the product. Read this guide carefully before using to ensure more safety usage. You can find more information on our website (www.inovance.com).

Approvals

Certification marks on the product nameplate indicate compliance with the corresponding certificates and standards.

Certification	Mark	Directives	Standard
CE		EMC directives	2014/30/EU EN61131-2
		LVD directives	2014/35/EU EN 61010-1 EN61010-2-201
		RoHS directives	2011/65/EU EN 50581

Note:

- For more information on certification, consult our distributor or sales representative.

2. Safety Information and Precautions

Safety information and precautions are identified into two grades: Warning and Caution. Please make sure to operate properly with adequate safety assurance.

WARNING Indicates the improper operation which, if not avoided, may cause death or serious injury.

CAUTION Indicates the improper operation which, if not avoided, may cause moderate or minor injury, as well as equipment damage.

In some cases, even failure to follow "Cautions" may also lead to serious consequences. Please make sure to follow both warnings and cautions, otherwise, it may cause death or serious injury, as well as product and relevant equipment and system damage.

Please keep this guide well so that it can be read when necessary and forward this guide to the end user.

During control system design

- WARNING** Provide a safety circuit outside the PLC so that the control system can still work safely once external power failure or PLC fault occurs.
- Add a fuse or circuit breaker because the module may smoke or catch fire due to long-time overcurrent caused by operation above rated current or load short-circuit.

During control system design

- CAUTION** An emergency stop circuit, a protection circuit, a forward/reverse operation interlocked circuit, and an upper position limit and lower position limit interlocked circuit must be set in the external circuits of PLC to prevent damage to the machine.
- To ensure safe operation, for the output signals that may cause critical accidents, please design external protection circuit and safety mechanism;
- Once PLC CPU detects abnormality in the system, all outputs may be closed; however, when a fault occurs in the controller circuit, the output may not be under control. Therefore, it is necessary to design an appropriate external control circuit to ensure normal operation;
- If the PLC's output units such as relays or transistors are damaged, the output may fail to switch between ON and OFF states according to the commands;
- The PLC is designed to be used in indoor electrical environment (overvoltage category II). The power supply must have a system-level lightning protection device, assuring that overvoltage due to lightning shock can't be applied to the PLC's power supply input terminals, signal input terminals and output terminals and so forth, so as to avoid damage to the equipment.

During installation & wiring

- WARNING** Installation and wiring must be carried out by the specialists who have received the necessary electrical training and understood enough electrical knowledge.
- Disconnect all external power supplies of the system before module assemble/disassemble and wiring. Failure to do so may result in electric shock, module fault or malfunction.
- Do not use the PLC where there are dust, oil smoke, conductive dust, corrosive or combustible gases, or exposed to high temperature, condensation, wind & rain, or subject to vibration and impact. Electric shock, fire and malfunction may also result in damage or deterioration to the product.
- The PLC is an open-type that must be installed in a control cabinet with lock (cabinet housing must satisfy protection of over IP20). Only the personnel who have the necessary electrical training and experience can open the cabinet.
- Install the terminal cover attached to the product before power-on or operation after wiring is completed. Failure to comply may result in electric shock.
- Perform good insulation on terminals so that insulation distance between cables will not reduce after cables are connected to terminals. Failure to comply may result in electric shock or damage to the equipment.

- CAUTION** Prevent metal filings and wire ends from dropping into ventilation holes of the PLC during installation and wiring. Failure to comply may result in fire, fault and malfunction.
- Ensure there are no foreign matters on ventilation surface. Failure to comply may result in poor ventilation, which may cause fire, fault and malfunction.
- Ensure the module is connected to the respective connector securely and hook the module firmly. Improper installation may result in malfunction, fault or fall-off.
- The external wiring specification and installation method must comply with local regulations. For details, see the wiring section in this guide.
- To ensure safety of equipment and operator, use cables with sufficient diameter and connect the cables to ground reliably.
- Wire the module correctly after making clear of the connector type. Failure to comply may result in module and external equipment fault.
- Tighten bolts on the terminal block in the specified torque range. If the terminal is not tight, short-circuit, fire or malfunction may be caused. If the terminal is too tight, fall-off, short-circuit, fire or malfunction may be caused.
- If the connector is used to connect with external equipment, perform correct crimping or welding with the tool specified by manufacturer. If connection is in poor contact, short-circuit, fire or malfunction may be caused.
- A label on the top of the module is to prevent foreign matters entering the module. Do not remove the label during wiring. Remember to remove it before system operation, facilitating ventilation.
- Do not bundle control wires, communication wires and power cables together. They must be run with distance of more than 100 mm. Otherwise, noise may result in malfunction.
- Select shielded cable for high-frequency signal input/output in applications with serious interference so as to enhance system anti-interference ability.

During maintenance & inspection

- WARNING** Maintenance & inspection must be carried out by personnel who have the necessary electrical training and experience.
- Do not touch the terminals while the power is on. Failure to comply may result in electric shock or malfunction.
- Disconnect all external power supplies of the system before cleaning the module or re-tightening screws on the terminal block or screws of the connector. Failure to comply may result in electric shock.
- Disconnect all external power supplies of the system before removing the module or connecting/removing the communication wirings. Failure to comply may result in electric shock or malfunction.

- CAUTION** Get acquainted with the guide and ensure safety before online modification, forcible output, and RUN/STOP operation.
- Disconnect the power supply before installing/removing the extension card.

At disposal

- CAUTION** Treat scrapped module as industrial waste. Dispose the battery according to local laws and regulations.

3. Product Information

Model and Nameplate

Mark	Description	Mark	Module Type
G	General Module	AD	Analog input
L	Local module		
Mark	Series	Mark	IO Point
10	10 series	4	4-channel

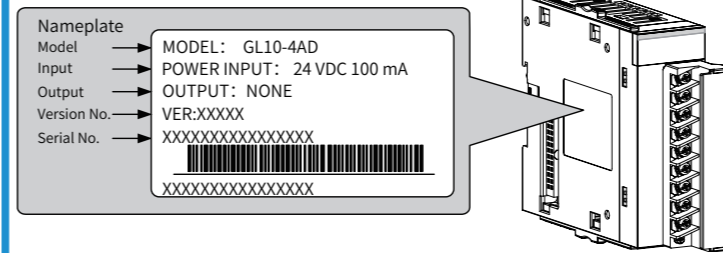

Figure 1 Description of model and nameplate

Model	Classification	Description	Applicable to
GL10-4AD	analog inputs	4-channel AD module, supporting analog voltage/current input	AM600 series, H3U

External Interface

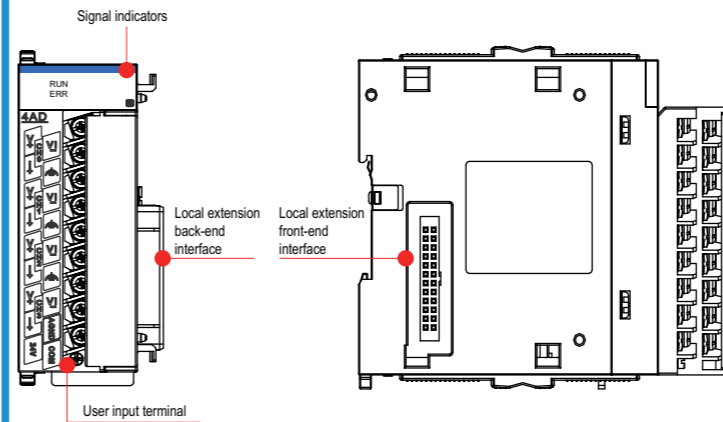

Figure 2 Diagram of the analog input modules interface

Interface Name	Function
User input terminal	4-channel input (supporting voltage or current input)
Signal indicators	RUN: operation state indicator, which is turned on during normal operation and turned off when a fault occurs ERR: error state indicator, which is turned on when a fault occurs
Local expansion module back-end interface	Connect back-end module, not supporting hot plugging
Local expansion module front-end interface	Connect front-end module, not supporting hot plugging

General Specifications

Item	Specifications
Input channel	4
Supply voltage	24 Vdc (20.4 Vdc to 28.8 Vdc) (-15% to +20%)
Internal 5 V power consumption	85 mA (typical value)
Voltage input impedance	> 1 MΩ
Current sampling impedance	250 Ω
Voltage input range	Bipolar: ±5 V, ±10 V; Unipolar: +5 V, +10 V
Current input range	0 mA to 20 mA, 4 mA to 20 mA, ±20 mA
Resolution	16 bits
Sampling time	1 ms
Accuracy (normal temperature: 25 °C)	Voltage: ±0.1%, current: ±0.1% (full ranges)

4. Mechanical Design Reference

Mounting Dimensions

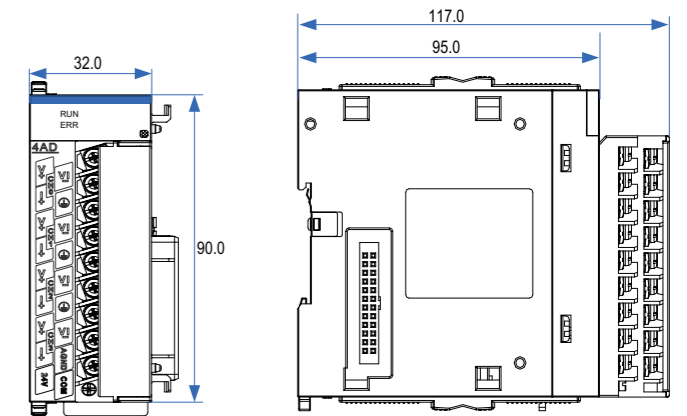

Figure 3 Mounting dimensions diagram (in mm)

5. Electrical Design Reference

Analog Module Cable Selection

Cable Name	Model	Applicable Cable Diameter		Manufacturer	Crimping Tool
		MM ²	AWG		
Y-type cable lug	TNS1.25-3	0.5-0.75	22-18	Suzhou Yuanli	RYO-8 YYT-8

Those cable lugs are applicable to digital/analog modules, and the cable rated temperature is required to be above 75 °C.

Cable Preparing Procedures

- Strip back the wire outer coating by 6 mm.
- Pass the cable through the tube of proper wire size.
- Insert the exposed end into the hole of the cable lug, and then crimp it with recommended crimping tool.
- Use heat-shrinkable tube (Φ3) of 20 mm long to wrap the copper tube of the cable lug and then perform thermal shrinkage.

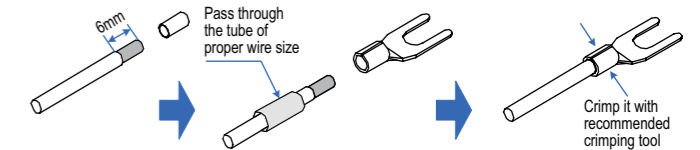

Figure 4 Diagram of cable preparing

- Put the cable lug onto the terminal and tighten the screw with a screwdriver. The maximum tightening torque is 0.8 N.m.

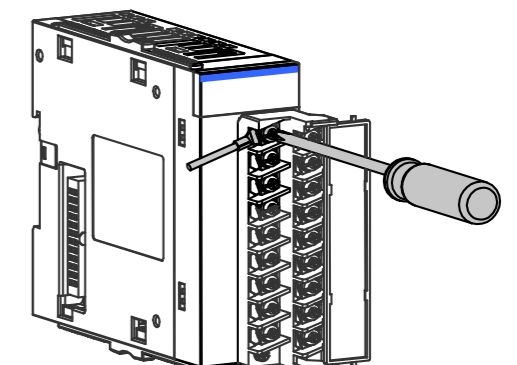

Figure 5 Connecting cable to terminal block

Terminal Arrangement

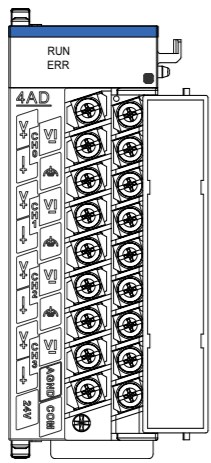
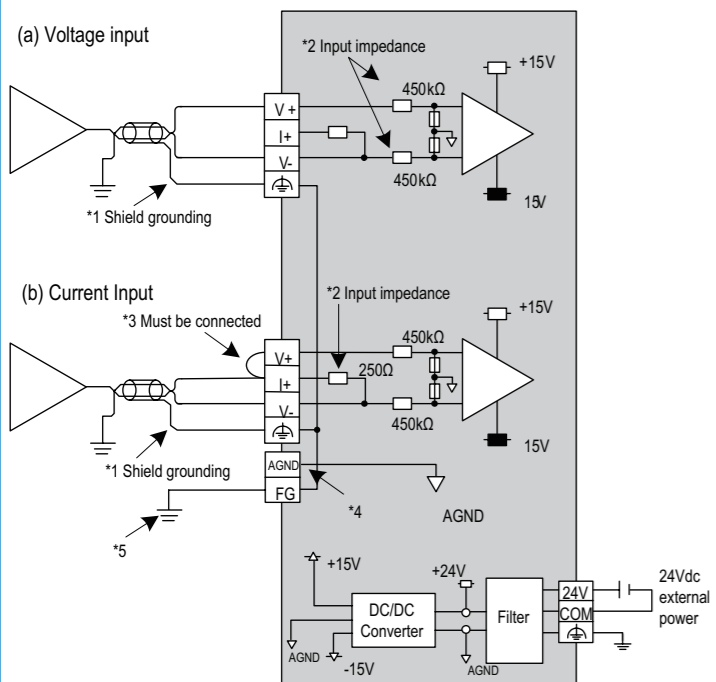

Figure 6 Terminal definition of analog input module

Terminal Definition

SN	Network Name	Type	Function	Remark
1	V+	Input	V+ of channel 0	Voltage input
2	VI-	Input	V-/I- of channel 0	Voltage/current input
3	I+	Input	I+ of channel 0	Current Input
4			Shielding ground	Internally connected to housing ground
5	V+	Input	V+ of channel 1	Voltage input
6	VI-	Input	V-/I- of channel 1	Voltage/current input
7	I+	Input	I+ of channel 1	Current Input
8			Shielding ground	Internally connected to housing ground
9	V+	Input	V+ of channel 2	Voltage input
10	VI-	Input	V-/I- of channel 2	Voltage/current input
11	I+	Input	I+ of channel 2	Current Input
12			Shielding ground	Internally connected to housing ground
13	V+	Input	V+ of channel 3	Voltage input
14	VI-	Input	V-/I- of channel 3	Voltage/current input
15	I+	Input	I+ of channel 3	Current Input
16	AGND	Analog ground	Analog ground	-
17	24 V	Power supply	24 V power supply	-
18	COM	Power ground	Power ground	-

External Wiring



*1 Use 2-core shielded twisted pair cable for analog signal.

*2 Indicates input impedance of 4AD.

*3 For current input, terminal (V+) must be connected to terminal (I+).

*4 When the input signal is a differential signal, "AGND" can be connected to analog ground of compatible devices to eliminate the difference of common mode voltage between devices and ensure the accuracy of module sampling.

*5 The module should be mounted on a well-grounded metal bracket, and ensure that the metal shrapnel at the bottom of the module is in good contact with the bracket.

Wiring Precautions

- 1) Do not bundle the cable together with AC cable, main lines, high voltage cable and so forth, otherwise it may result in an increased noise, surge and induction.
- 2) Apply single-point grounding for the shielding of shielded cable and solder sealed cable.
- 3) Tubed and solderless crimp terminal can't be used with terminal block. Using marking sleeve or insulation sleeve to cover the cable connector part of the crimp terminals is recommended. cover the cable connector part of the crimp terminals is recommended.

6. Programming Examples

Use AM600 or H3 as the main control module, sample the voltage of GL10-4AD module's channel 0 and assign the sampling values. to related tags

Programming Example for AM600+GL10-4AD Module

- 1) Configure hardware in project

Create a project and configure hardware as follows:

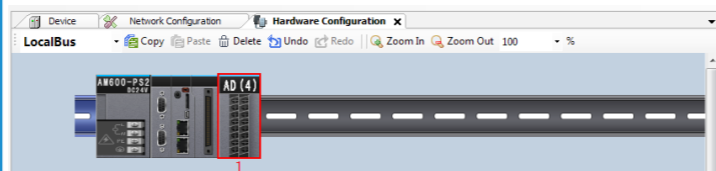

- 2) Channel configuration

Double-click GL10-4AD module, in "General Configuration" interface, enable Channel-0, and configure "Conversion Mode" as "-10V~10V" voltage input. "Channel diagnosis upwards reported" can also be configured.

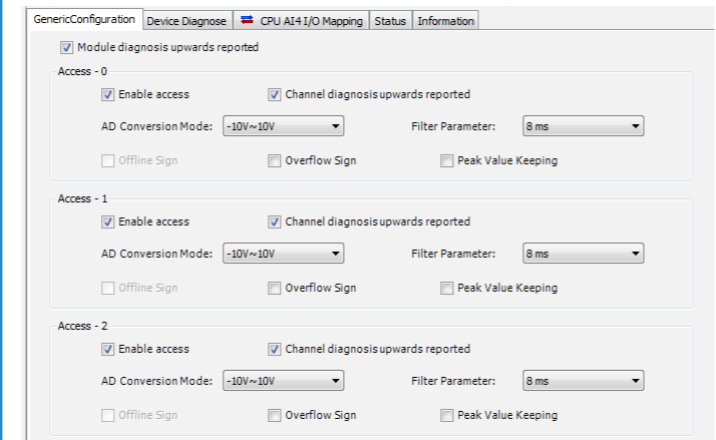

- 3) Define tags

Use ST programming language to program, as shown in the figure below. Define CH0 and AD_CH0 tags, and assign the value of CH0, the tag mapping from sampling channel 0, to AD_CH0 tag.

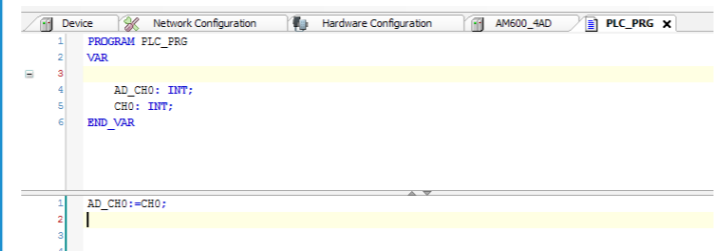

- 4) Tag mapping

Map the CH0 tag defined during programming to channel 0 of the configured GL10-4AD module to complete tag mapping.

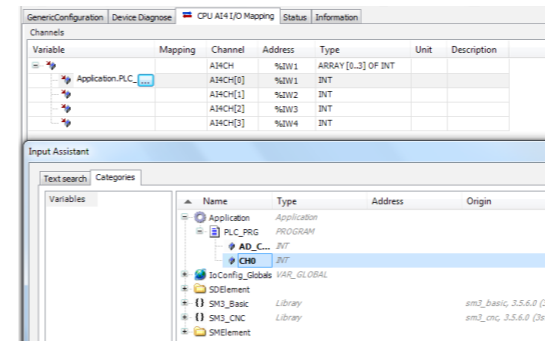

- 5) After successful compiling, download the project and run it.

Programming Example for H3U + GL10-4AD Module

- 1) Open the configuration interface in project

Create a project, select "H3U". Then the system enters the main page.

- ① Click "Configuration";
- ② Right-click "Network Configuration", and then click "Create a New Module Configuration";
- ③ The simulation graphics of the rack to be configured appears:

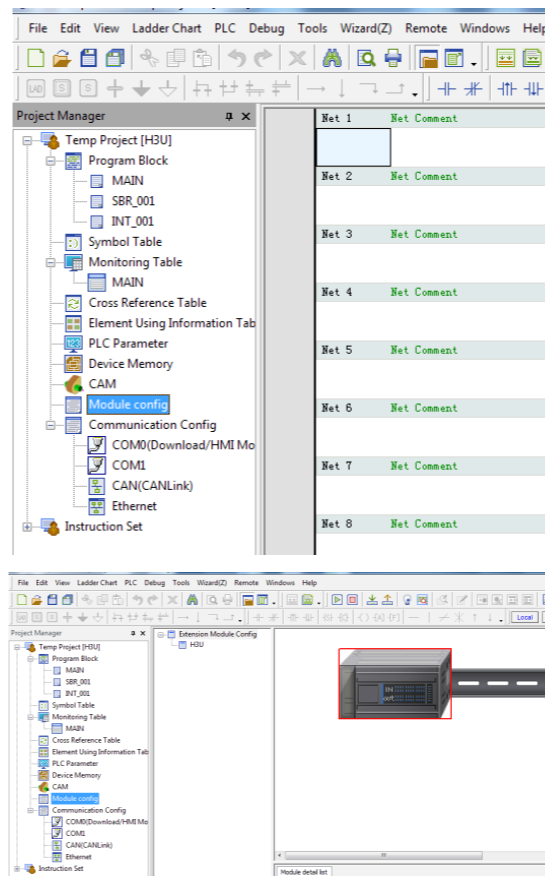

- 2) Add GL10-4AD module in project

Select the module GL10-4AD to be added from the module list. Double-click the module to automatically add it to the expansion rack, or use left mouse button to drag it onto the expansion rack.

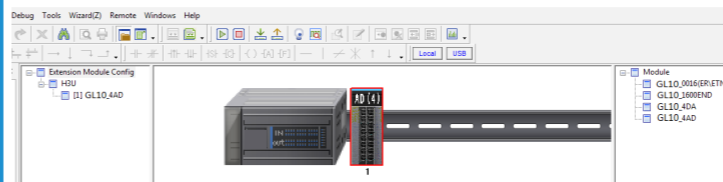

- 3) Configuration of module parameters

Double-click the GL10-4AD module on the rack, and the configuration interface appears (as below). In the configuration interface, enable Channel-1, and configure "Translate" as "-10V~10V" voltage output. Parameters such as "Filtering" can also be configured.

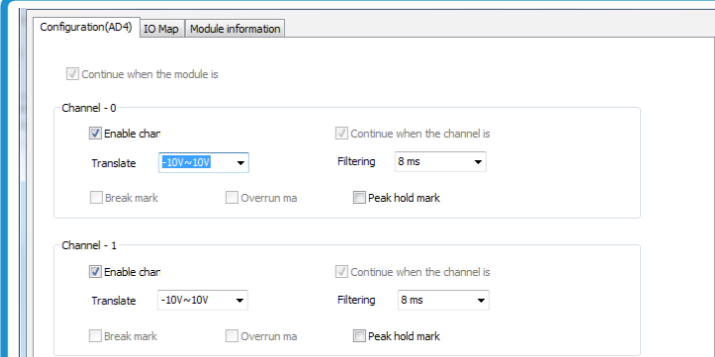

- 4) I/O mapping

On the "IO Map" tab page, map CH0 of 4AD module to D0 of element D.

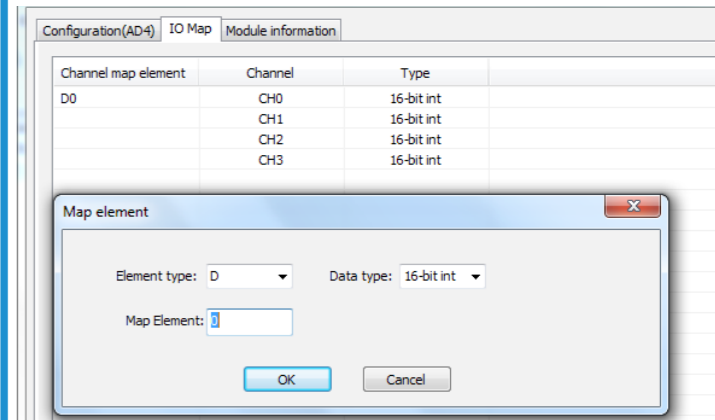

- 5) Sampling programming

Use ladder graphic programming language to program AD sampling. Change mapping tag of CH0 from D0 to D200.

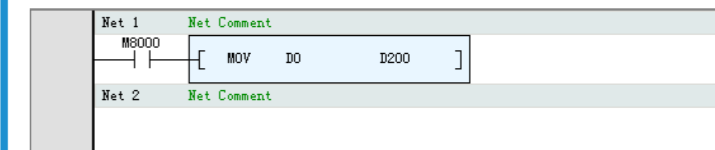

- 6) After successful compiling, download the project and run it.

INOVANCE Warranty Agreement

- 1) Inovance provides an 18-month free warranty to the equipment itself from the date of manufacturing for the failure or damage under normal use conditions.
- 2) Within the warranty period, maintenance will be charged for the damage caused by the following reasons:
 - a. Improper use or repair/modification without prior permission
 - b. Fire, flood, abnormal voltage, natural disasters and secondary disasters
 - c. Hardware damage caused by dropping or transportation after procurement
 - d. Operations not following the user instructions
 - e. Damage out of the equipment (for example, external device factors)
- 3) The maintenance fee is charged according to the latest Maintenance Price List of Inovance.
- 4) If there is any problem during the service, contact Inovance's agent or Inovance directly.
- 5) Inovance reserves the rights for explanation of this agreement.

Suzhou Inovance Technology Co., Ltd.
 Address: No.16, Youxiang Road, Yuexi Town, Wuzhong District, Suzhou 215104, P.R. China
 Website: <http://www.inovance.com>